



Network Security

Chapter 4

The IPSec Security Architecture



- Introduction
 - Brief introduction to the Internet Protocol (IP) suite
 - Security problems of IP and objectives of IPSec
- The IPSec architecture:
 - Overview
 - IP Replay Protection
 - IPSec security protocol modes:
 - Transport mode
 - Tunnel mode
 - IP Security Policies and the Security Policy Database (SPD)
 - Security associations (SA) and the SA Database (SAD)
 - Implementation alternatives
- IPSec security protocols:
 - Encapsulating Security Payload (ESP)
 - Authentication Header (AH)
- Entity Authentication and Key Establishment with the Internet Key Exchange (IKE)



The TCP/IP Protocol Suite

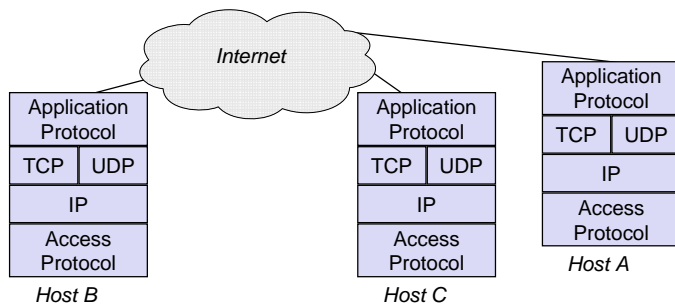

- *IP (Internet Protocol)*: unreliable, connectionless network protocol
- *TCP (Transmission Control Protocol)*: reliable, connection-oriented transport protocol
- *UDP (User Datagram Protocol)*: unreliable, connectionless transport protocol
- Examples for *application protocols*:
 - HTTP: Hypertext Transfer Protocol
 - SMTP: Simple Mail Transfer Protocol



The IP Packet Format (1)

Ver.	IHL	TOS	Length	
IP Identification		Flags	Fragment Offset	
TTL	Protocol		IP Checksum	
Source Address				
Destination Address				
IP Options (if any)				
TCP / UDP / ... Payload				

- *Version (Ver.)*: 4 bit
 - Currently version 4 is widely deployed
 - Version 6 is not widely deployed, and it is not yet clear to which extent it will be generally deployed
- *Internet header length (IHL)*: 4 bit
 - Length of the IP header in 32-bit words (i.e. no options ⇒ IHL=5)
- *Type of service (TOS)*: 8 bit
 - The field originally has been defined to indicate service requirements
 - It has been redefined for DiffServ Code Points and Explicit Congestion Notification

The IP Packet Format (2)

- **Length:** 16 bit
 - The length of the packet including the header in octets
 - This field is, like all other fields in the IP suite, in “big endian” representation (i.e., network byte order)
- **Identification:** 16 bit
 - Used to “uniquely” identify an IP datagram
 - Important for reassembling of fragmented IP packets
- **Flags:** 3 bit
 - Bit 1: do not fragment
 - Bit 2: datagram fragmented
 - Bit 3: reserved for future use
- **Fragmentation offset:** 13 bit
 - The position of this packet in the corresponding IP datagram
- **Time to live (TTL):** 8 bit
 - At every processing network node, this field is decremented by one
 - When TTL reaches 0 the packet is discarded to avoid packet looping

The IP Packet Format (3)

- **Protocol:** 8 bit
 - Indicates the (transport) protocol of the payload
 - Used by the receiving end system to de-multiplex packets among various transport protocols like TCP, UDP, ...
- **Checksum:** 16 bit
 - Protection of header against transmission errors
 - Note well: it is not a cryptographic checksum
- **Source address:** 32 bit
 - The IP address of sender of this packet
- **Destination address:** 32 bit
 - The IP address of the intended receiver of this packet
- **IP Options:** variable length
 - An IP header can optionally carry additional information
 - As they are not important to IPSec, IP options are not be discussed in this course

Security Problems of the Internet Protocol

- When an entity receives an IP packet, it has no assurance of:
 - **Data origin authentication / data integrity:**
 - The packet has actually been sent by the entity which is referenced by the source address of the packet
 - The packet contains the original content the sender placed into it, so that it has not been modified during transport
 - The receiving entity is in fact the entity to which the sender wanted to send the packet
 - **Confidentiality:**
 - The original data was not inspected by a third party while the packet was sent from the sender to the receiver

Security Objectives of IPSec

- IPSec aims to ensure the following security objectives:
 - **Data origin authentication / connectionless data integrity:**
 - It is not possible to send an IP datagram with neither a masqueraded IP source nor destination address without the receiver being able to detect this
 - It is not possible to modify an IP datagram in transit, without the receiver being able to detect the modification
 - **Replay protection:** it is not possible to later replay a recorded IP packet without the receiver being able to detect this
 - **Confidentiality:**
 - It is not possible to eavesdrop on the content of IP datagrams
 - Limited traffic flow confidentiality
- **Security policy:**
 - Sender, receiver and intermediate nodes can determine the required protection for an IP packet according to a local security policy
 - Intermediate nodes and the receiver will drop IP packets that do not meet these requirements

Overview

Introduction

- Brief introduction to the Internet Protocol (IP) suite
- Security problems of IP and objectives of IPsec

The IPsec architecture:

- Overview
- IP Replay Protection
- IPsec security protocol modes:
 - Transport mode
 - Tunnel mode
- IP Security Policies and the Security Policy Database (SPD)
- Security associations (SA) and the SA Database (SAD)
- Implementation alternatives

IPsec security protocols:

- Encapsulating Security Payload (ESP)
- Authentication Header (AH)

Entity Authentication and Key Establishment with the Internet Key Exchange (IKE)

Overview of the IPsec Architecture (1)

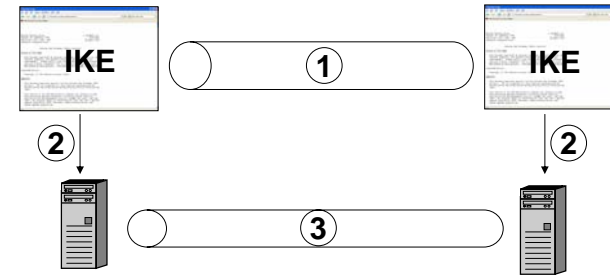

- Authentication, key establishment and negotiation of cryptographic algorithms
 - Protocols: ISAKMP, Internet Key Exchange (IKE), IKEv2
- Set keys and cryptographic algorithms
- Secure channel, which provides
 - Data integrity: using the Authentication Header (AH) protocol or the Encapsulating Security Payload (ESP)
 - Confidentiality using ESP
 - Note: ESP can provide both data integrity and encryption while AH provides only data integrity

Overview of the IPsec Standardization Documents

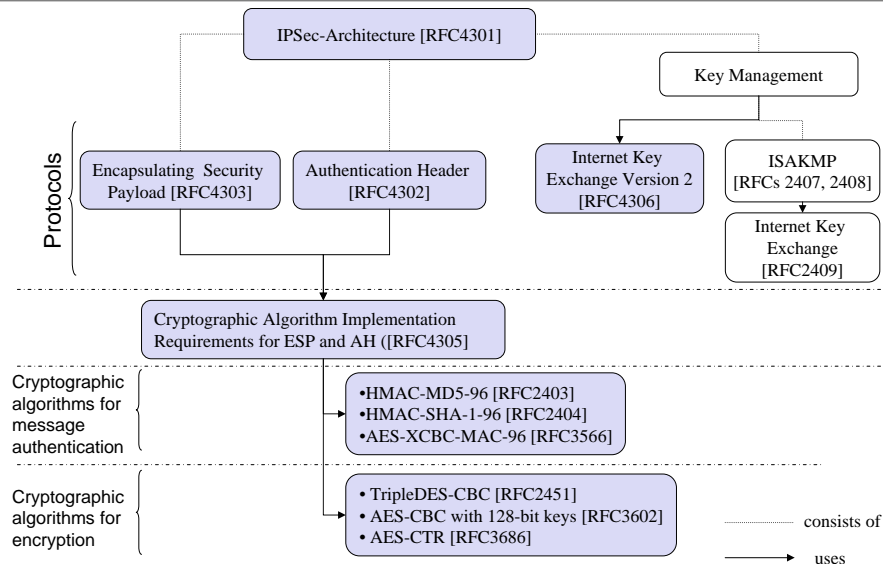

Overview of the IPsec Architecture (2)

- RFC 4301 defines the basic architecture of IPsec:
 - Concepts:
 - Security association (SA), security association database (SAD)
 - Security policy, security policy database (SPD)
 - Fundamental IPsec Protocols:
 - Authentication Header (AH)
 - Encapsulating Security Payload (ESP)
 - Protocol Modes:
 - Transport Mode
 - Tunnel Mode
 - Key management protocols:
 - ISAKMP, IKE, IKEv2
- A list of most RFCs related to IPsec can be found here
 - <http://www.ietf.org/html.charters/OLD/ipsec-charter.html>
- Most of the RFCs have been updated in 2005 (after several years of revision)
 - Support of integration of new cryptographic primitives for encryption and data integrity easily
 - Reduced complexity by better protocol design and by omitting some useless features

Overview of the IPSec Architecture (3)

- The authentication header (AH):
 - Provides data origin authentication and replay protection
 - Is realized as a header which is inserted between the IP header and the data to be protected

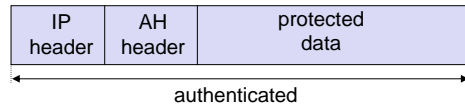

- The encapsulating security payload (ESP):
 - Provides data origin authentication, confidentiality and replay protection
 - Is realized with a header and a trailer encapsulating the data to be protected

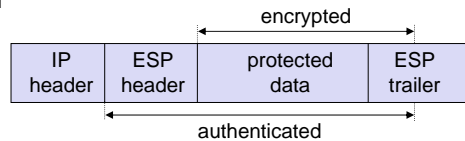

Overview of the IPSec Architecture (4)

- Key management and setup of security associations is realized with:
 - Internet Security Association Key Management Protocol (ISAKMP):
 - Defines generic framework for key authentication, key exchange and negotiation of security association parameters [RFC2408]
 - Does not define a specific authentication protocol, but specifies:
 - Packet formats
 - Retransmission timers
 - Message construction requirements
 - Use of ISAKMP for IPSec is further detailed in [RFC2407]
 - Internet Key Exchange (IKE):
 - Defines an authentication and key exchange protocol [RFC2409]
 - Is conformant to ISAKMP and may be used for different applications
 - Setup of IPSec SAs between two entities is realized in two phases:
 - Establishment of an IKE SA (defines how to setup IPSec SAs)
 - Setup of IPSec SAs
 - Internet Key Exchange Version 2 [RFC4306]
 - Reduced complexity by better protocol design and by omitting some useless features

IPSec Replay Protection (1)

- Both AH- and ESP-protected IP packets carry a sequence number which realizes a replay protection:
 - When setting up a security association (SA) this sequence number is initialized to zero
 - The sequence number is increased with every IP packet sent
 - The sequence number is 32 bit long, and a new session key is needed before a wrap-around occurs
 - The receiver of an IP packet checks if the sequence number is contained in a window of acceptable numbers

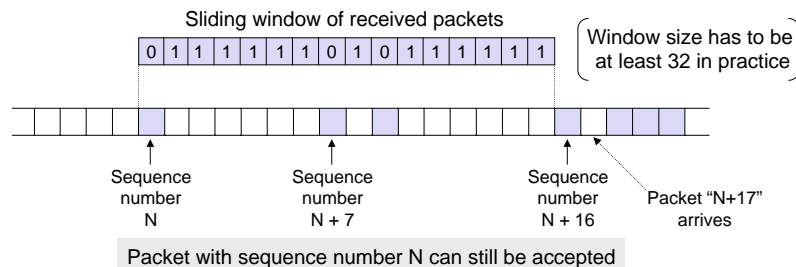

IPSec Replay Protection (2)

- If a received packet has a sequence number which:
 - is left of the current window ⇒ the receiver rejects the packet
 - is inside the current window ⇒ the receiver accepts the packet
 - is right of the current window ⇒ the receiver accepts the packet and advances the window

Of course IP packets are only accepted if they pass the authentication verification and the window is never advanced before this verification
- The minimum window size is 32 packets (64 packets is recommended)

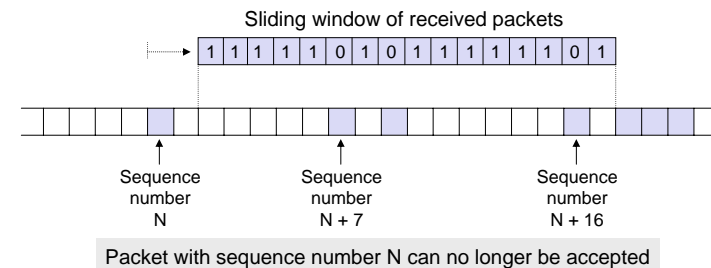

IPSec Modes

- IPSec works in two modes:
 - *Transport mode* can only be used between end-points of a communication:
 - host ↔ host, or
 - host ↔ gateway, if the gateway is a communication end-point (e.g. for network management)
 - *Tunnel mode* can be used with arbitrary peers
- The difference between the two modes is, that:
 - Transport mode just adds a security specific header (+ possibly a trailer):



- Tunnel mode encapsulates IP packets:

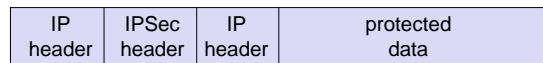

Encapsulation of IP packets allows for a gateway protecting traffic on behalf of other entities (e.g. hosts of a subnetwork, etc.)

IPSec Transport Mode

- Transport mode is used when the “cryptographic endpoints” are also the “communication endpoints” of the secured IP packets
 - Cryptographic endpoints: the entities that generate / process an IPSec header (AH or ESP)
 - Communication endpoints: source and destination of an IP packet

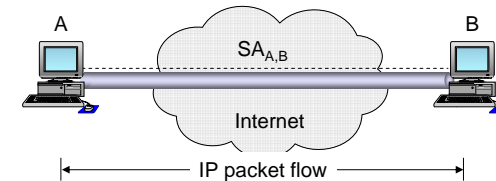

- In most cases, communication endpoints are hosts (workstations, servers), but this is not necessarily the case:
 - Example: a gateway being managed via SNMP by a workstation

IPSec Tunnel Mode (1)

- Tunnel mode is used when at least one “cryptographic endpoint” is not a “communication endpoint” of the secured IP packets
 - This allows for gateways securing IP traffic on behalf of other entities

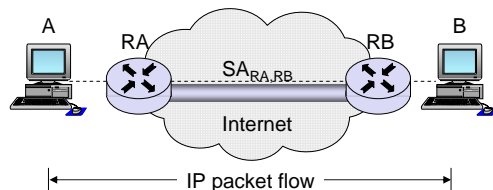

packet structure

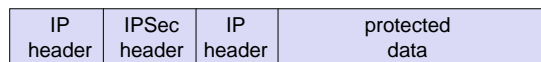

Src = RA Src = A
 Dst = RB Dst = B

IPSec Tunnel Mode (2)

- The above description of application scenarios for tunnel mode includes the case in which only one cryptographic endpoint is not a communication endpoint:
 - Example: a security gateway ensuring authentication and / or confidentiality of IP traffic between a local subnetwork and a host connected via the Internet (“road warrior scenario”)

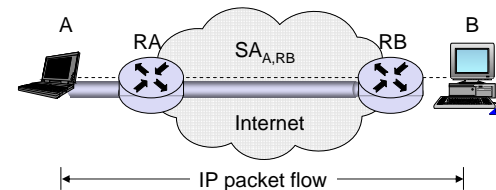

packet structure

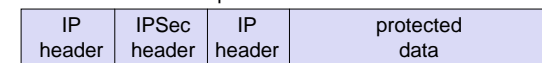

Src = A Src = A
 Dst = RB Dst = B

Traffic Selectors

- ❑ A Traffic Selector (TS) is a set of properties used to characterize IP packets
- ❑ Each TS may contain the following information
 - *IP source address:*
 - Specific host, network prefix, address range, or wildcard
 - *IP destination address:*
 - Specific host, network prefix, address range, or wildcard
 - In case of incoming tunneled packets the inner header is evaluated
 - *Name:*
 - DNS name, X.500 name or other name types
 - *Protocol:*
 - The protocol identifier of the transport protocol for this packet (e.g. TCP or UDP)
 - This may not be accessible when a packet is secured with ESP

IPSec Security Policy Definition

- ❑ Traffic Selectors are used to define security policies in the SPD
- ❑ A policy definition specifies:
 - Which and how security services should be provided to IP packets:
 - *Selectors* that identify specific IP flows
 - Required *Security attributes* for each flow:
 - *Security protocol:* AH or ESP
 - *Protocol mode:* transport or tunnel mode
 - *Other parameters:* e.g. policy lifetime
 - *Action:* discard, secure, bypass
- ❑ The security policies are stored in the security policy database (SPD)
- ❑ Note
 - since it is possible to include port numbers (i.e., layer 4 addresses) in the traffic selector of a security policy, IPSec protection can be specified for specific applications running on a host

IPSec Security Associations (1)

- ❑ A *security association (SA)* is a simplex “connection” that describes the way how outgoing/incoming packets need to be processed, such as encryption/authentication algorithms and encryption/authentication keys
- ❑ An SA is associated with either AH or ESP, but not both
- ❑ For bi-directional communication two security associations are needed
- ❑ An SA can be set up between the following peers:
 - Host ↔ Host
 - Host ↔ Gateway (or vice versa)
 - Gateway ↔ Gateway
- ❑ Security associations are stored in the security association database (SAD)

IPSec Security Associations (2)

- ❑ An SA is uniquely identified by a *security parameter index (SPI)*
- ❑ The SPI value is specified by the receiving side during SA negotiation.
- ❑ An SAD entry for an outbound SA specifies the SPI used when constructing the AH or ESP header.
- ❑ For an SAD entry of an inbound SA, the SPI is used to map traffic to the appropriate SA.

IPSec Security Associations (3)

- An SA entry in the SAD includes the following information
 - IP source address
 - IP destination address
 - a security protocol identifier (AH / ESP)
 - Current sequence number counter (for replay protection)
 - AH authentication algorithm and key (if it is an AH SA)
 - ESP encryption and integrity algorithms, keys, mode, IV (if it is an ESP SA)
 - SA lifetime
 - IPSec protocol mode: tunnel mode or transport mode
 - Additional information
 - (See RFC 4301, Section 4.4.2.1. "Data Items in the SAD")

Basic Scheme of IPSec Processing: Outgoing Packets (1)

- Consider the IP layer of a node (host / gateway) is told to send an IP packet to another node (host / gateway)
- In order to support IPSec it has to perform the following steps:
 - Determine if and how the outgoing packet needs to be secured:
 - This is realized by performing a lookup in the SPD based on the traffic selectors
 - If the policy specifies "discard" then drop the packet ⇒ done
 - If the packet does not need to be secured, then send it ⇒ done
 - Determine which SA should be applied to the packet (based on the IP addresses, possibly ports)
 - If there is not yet an appropriate SA established with the corresponding node, then ask the key management process to perform IKE
 - Look up the determined (or freshly created) SA in the SAD
 - Perform the "security transforms" determined by the SA by using the algorithm, its parameters and the key as specified in the SA
 - This results in the construction of an AH or an ESP header
 - Possibly a new (outer) IP header will be created (tunnel mode)
 - Send the resulting IP packet ⇒ done

Basic Scheme of IPSec Processing: Outgoing Packets (2)

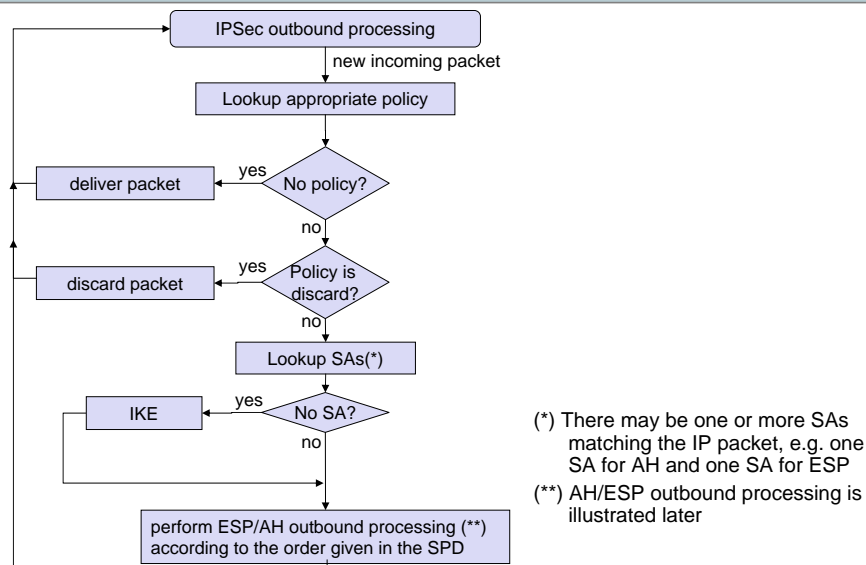

Basic Scheme of IPSec Processing: Incoming Packets

- Consider the IP layer of a node (host / gateway) receives an IP packet from another node (host / gateway)
- In order to support IPSec it has to perform the following steps:
 - For packets containing an IPSec header this entity is supposed to process:
 - Extract the SPI from the IPSec header, look up the SA in the SAD and perform the appropriate AH/ESP processing
 - If there is no SA referenced by the SPI, drop the packet
 - After AH and/or ESP processing, determine if and how the packet should have been protected:
 - This is again realized by performing a lookup in the SPD, with the lookup being performed by evaluating the inner IP header in case of tunneled packets
 - If the policy specifies "discard" then drop the packet
 - If the protection of the packet did not match the policy, drop the packet
 - This can be the case, e.g. if the policy enforces both AH and ESP protection, while the packet includes a AH header
 - If the packet had been properly secured, then deliver it to the appropriate protocol entity (network / transport layer)

Basic Scheme of IPSec Processing: Incoming Packets (2)

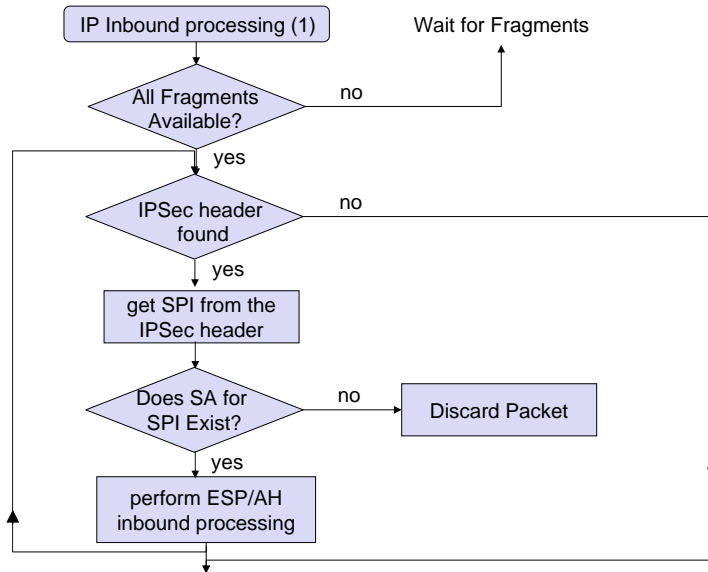

Basic Scheme of IPSec Processing: Incoming Packets (3)

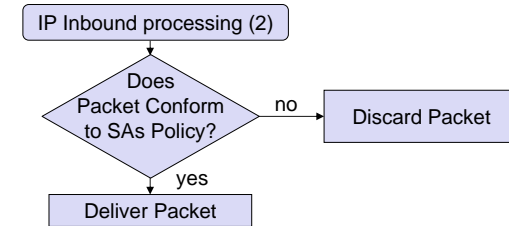

Example: IPSec Processing (1)

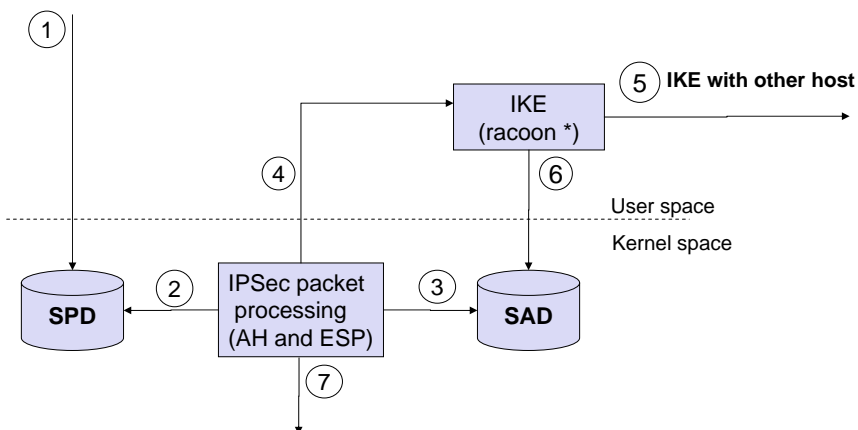

□ (*) *racoon* is a widespread IKE implementation in Linux

Example: IPSec Processing (2)

- 1) The administrator sets a policy in SPD
- 2) The IPSec processing module in the kernel refers to SPD in order to make a decision on applying IPSec to a packet.
- 3) If IPSec is required, then the IPSec processing module looks for the IPSec SA in SAD.
- 4) If there is no SA yet, then the IPSec processing module sends a request to IKE process (*racoon*) to get an SA
- 5) IKE process (*racoon*) performs a key exchange and negotiation of the cryptographic algorithms with the peer host using the IKE/IKEv2 protocol
- 6) IKE process (*racoon*) put the Key and all the required parameters into SAD
- 7) The IPSec processing module can send a packet applied IPSec

Example of IPSec Security Policies (1)

- Example: IPv6. Security protocol is **ESP**. Encapsulation mode is **Transport**.



- Configuration at Host A:
 - spdadd fec0::1 fec0::2 any -P out ipsec esp/transport//require ;
 - spdadd fec0::2 fec0::1 any -P in ipsec esp/transport//require ;
- Note
 - First IP address means source in the IP header
 - Next IP address means destination in the IP header
 - out** means this policy holds for outgoing packet
 - in** means this policy holds for an incoming packet
- Configuration at Host B:
 - spdadd fec0::2 fec0::1 any -P out ipsec esp/transport//require ;
 - spdadd fec0::1 fec0::2 any -P in ipsec esp/transport//require ;

Example of IPSec Security Policies (2)

- Example: **ESP Transport** mode applied first and **AH Transport** mode next

- It means that the resulting packets looks as follow:

IP	AH	ESP	Protected data
----	----	-----	----------------



- Configuration at Host A:
 - spdadd fec0::1 fec0::2 any -P out ipsec esp/transport//require ah/transport//require ;
 - spdadd fec0::2 fec0::1 any -P in ipsec esp/transport//require ah/transport//require ;
- Note the ordering of the security protocol
- Configuration at Host B:
 - spdadd fec0::2 fec0::1 any -P out ipsec esp/transport//require ah/transport//require ;
 - spdadd fec0::1 fec0::2 any -P in ipsec esp/transport//require ah/transport//require ;

Example of IPSec Security Policies (3)

- ESP Tunnel** for VPN

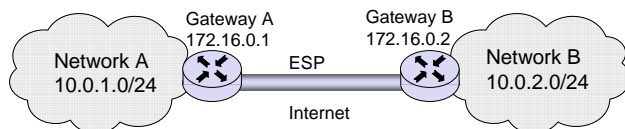

- Configuration at Gateway A:
 - spdadd 10.0.1.0/24 10.0.2.0/24 any -P out ipsec esp/tunnel/172.16.0.1-172.16.0.2/require ;
 - spdadd 10.0.2.0/24 10.0.1.0/24 any -P in ipsec esp/tunnel/172.16.0.2-172.16.0.1/require ;
- Configuration at Gateway B:
 - spdadd 10.0.2.0/24 10.0.1.0/24 any -P out ipsec esp/tunnel/172.16.0.2-172.16.0.1/require ;
 - spdadd 10.0.1.0/24 10.0.2.0/24 any -P in ipsec esp/tunnel/172.16.0.1-172.16.0.2/require ;

Example: Setup of Security Associations

- Note: it is also possible to set a SA manually
- e.g. for manually setting up an AH SA

```
# add src dst proto spi -A authalgo key;
add 3.0.0.1 5.0.0.1 ah 700 -A hmac-md5 0xbf9a081e7ebdd4fa824c822ed94f5226;
add 5.0.0.1 3.0.0.1 ah 800 -A hmac-md5 0xbf9a081e7ebdd4fa824c822ed94f5226;
```

- e.g. for manually setting up an ESP SA

```
# add src dst proto spi -E encalgo key;
add 3.0.0.1 5.0.0.1 esp 701 -E 3des-cbc
0x3f0b868ad03e68acc6e4e4644ac8bb80ecea3426d3d30ada;
add 5.0.0.1 3.0.0.1 esp 801 -E 3des-cbc
0x3f0b868ad03e68acc6e4e4644ac8bb80ecea3426d3d30ada;
```

- Note however that setting up SA manually is error-prone
 - The administrator might choose insecure keys
 - The set of SAs might be inconsistent
- It is better to rely on an IKE daemon for setting up SAs

Overview

- Introduction
 - Brief introduction to the Internet Protocol (IP) suite
 - Security problems of IP and objectives of IPsec
- The IPsec architecture:
 - Overview
 - IP Replay Protection
 - IPsec security protocol modes:
 - Transport mode
 - Tunnel mode
 - IP Security Policies and the Security Policy Database (SPD)
 - Security associations (SA) and the SA Database (SAD)
 - Implementation alternatives
- IPsec security protocols:
 - Encapsulating Security Payload (ESP)
 - Authentication Header (AH)
- Entity Authentication and Key Establishment with the Internet Key Exchange (IKE)

The Encapsulating Security Payload (1)

- ESP is a generic security protocol that provides to IP packets replay protection and one or both of the following security services:
 - Confidentiality, by encrypting encapsulated packets or just their payload
 - Data origin authentication, by creating and adding MACs to packets
- The ESP definition is divided into two parts:
 - The definition of the base protocol [RFC4303]:
 - Definition of the header and trailer format
 - Basic protocol processing
 - Tunnel and transport mode operation

The Encapsulating Security Payload (2)

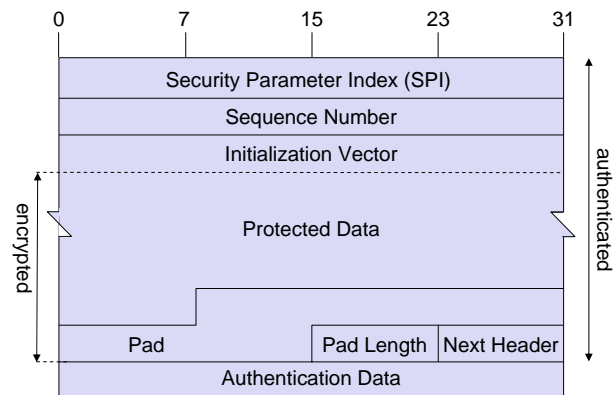

- The ESP header immediately follows an IP header or an AH header
- The next-header field of the preceding header indicates “50” for ESP

The Encapsulating Security Payload (3)

- The SPI (Security Parameter Index) field indicates the SA to be used for this packet:
 - The SPI value is always determined by the receiving side during SA negotiation as the receiver has to process the packet
- The sequence number provides replay protection as explained before
- If the cryptographic algorithm in use requires an initialization vector, it is transmitted in the clear in every packet at the beginning of the payload
- The pad field serves to ensure:
 - padding of the payload up to the required block length of the cipher in use
 - padding of the payload to right-justify the pad-length and next-header fields into the high-order 16 bit of a 32-bit word
- The pad length indicates the amount of padding bytes added
- The next-header field of the ESP header indicates the encapsulated payload:
 - In case of tunnel mode: IP
 - In case of transport mode: any higher-layer protocol as TCP, UDP, ...
- The optional authentication data field contains a MAC, if present

The Encapsulating Security Payload (4)

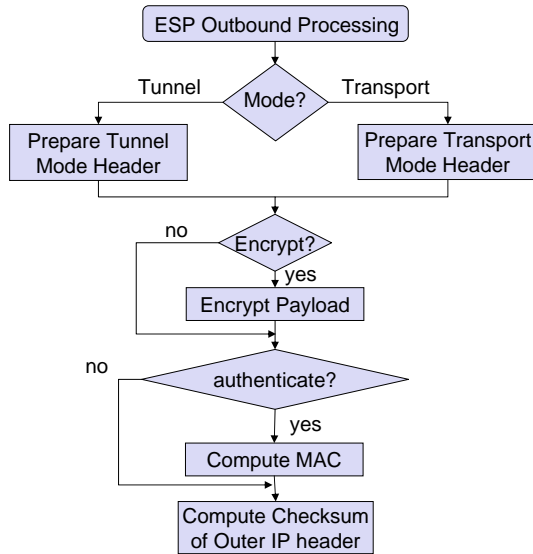

The Encapsulating Security Payload (5)

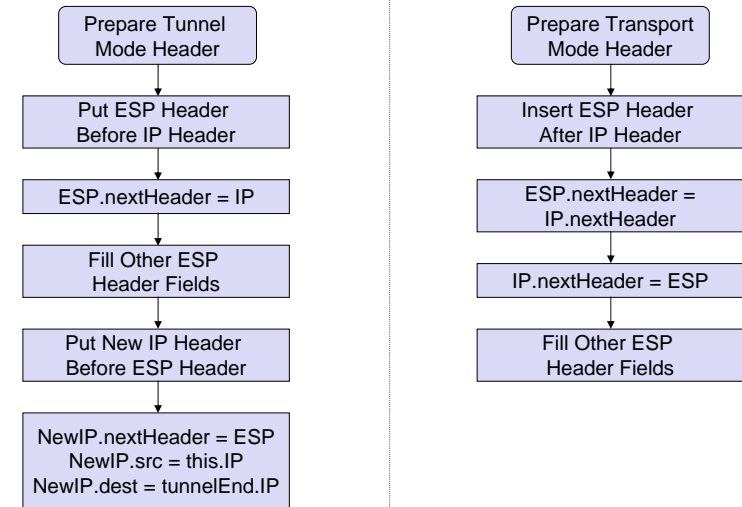

The Encapsulating Security Payload (6)

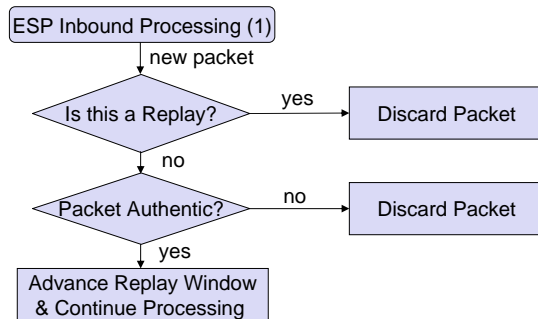

The Encapsulating Security Payload (7)

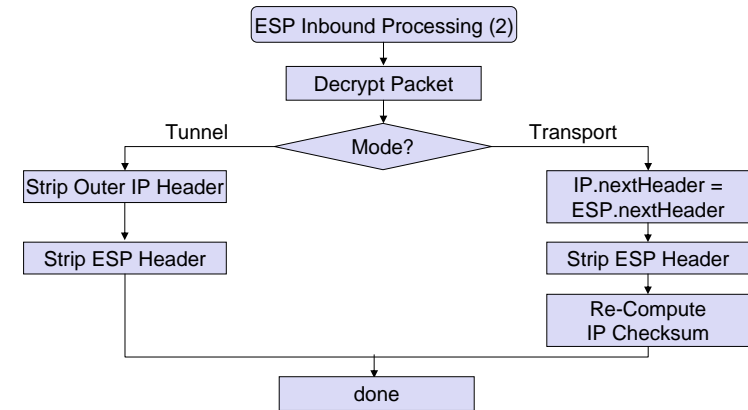

The Authentication Header (1)

- AH is a generic security protocol that provides to IP packets:
 - Replay protection
 - Data origin authentication, by creating and adding MACs to packets that refer to the IP header
- Like ESP, the AH definition is divided into two parts:
 - The definition of the base protocol [RFC4302]:
 - Definition of the header format
 - Basic protocol processing
 - Tunnel and transport mode operation
 - The use of specific cryptographic algorithms with AH:
 - Authentication: HMAC-MD5-96 [RFC2403], HMAC-SHA-96 [RFC2404]
- If both ESP and AH are to be applied by one entity, then ESP can be applied first (but it can the other way around):
 - This results in AH being the outer header
 - Advantage: the ESP header can also be protected by AH
 - Remark: two SAs (one for each AH, ESP) are needed for each direction

The Authentication Header (2)

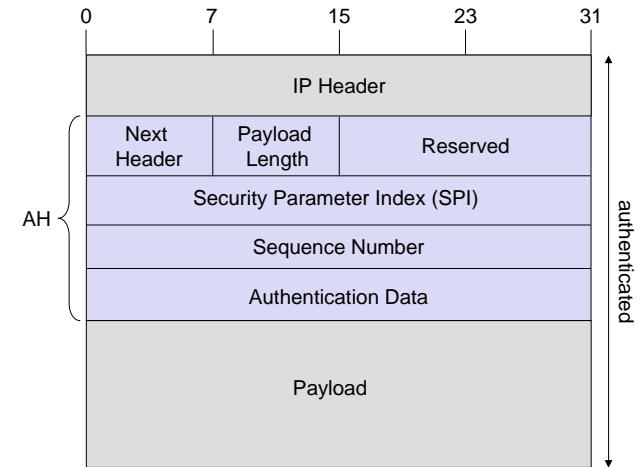

- The AH header immediately follows an IP header
- The next-header field of the preceding header indicates "51" for AH
- In tunnel mode the payload is a complete IP packet

The Authentication Header (3)

- Although AH also protects the outer IP header, some of its fields *must not* be protected as they are subject to change during transit:
 - This also applies to mutable IPv4 options or IPv6 extensions
 - Such fields are assumed being zero when computing the MAC

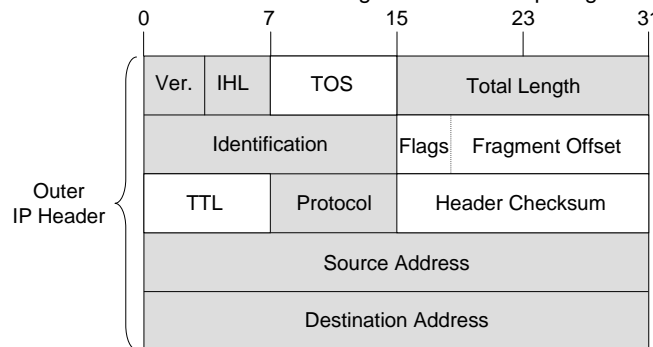

- All immutable fields, options and extensions (gray) are protected

The Authentication Header (4)

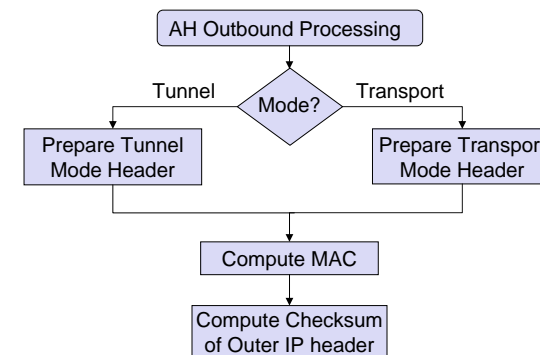

The Authentication Header (5)

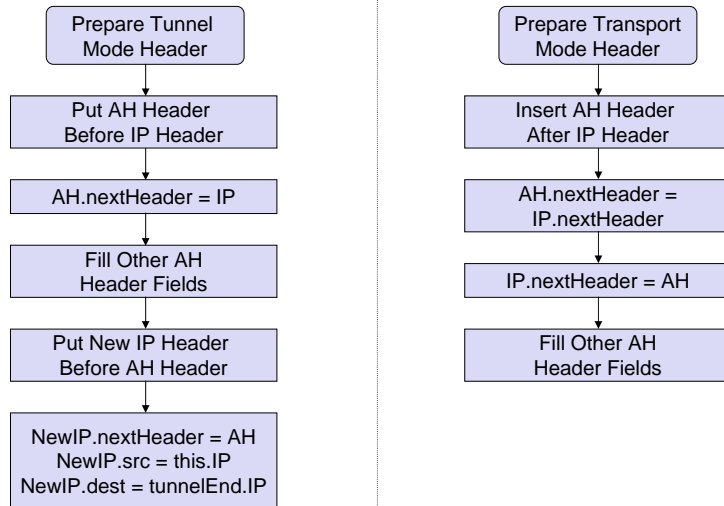

The Authentication Header (6)

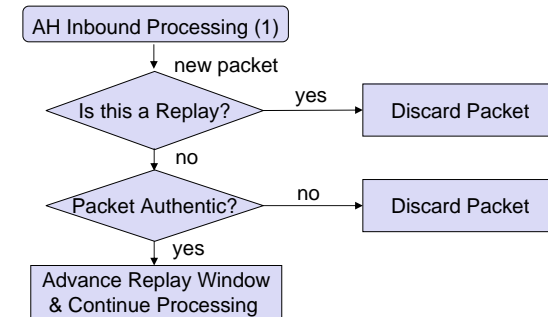

The Authentication Header (7)

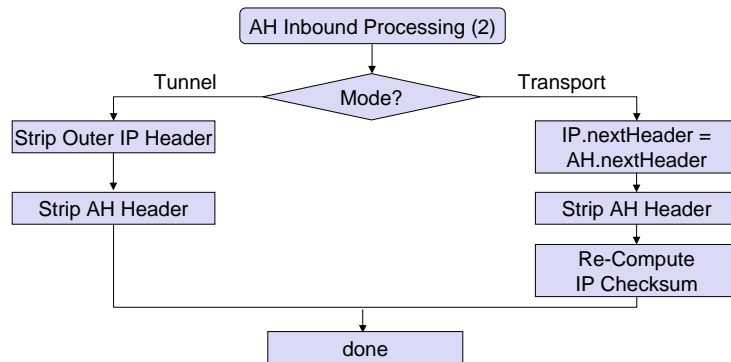

IPSec's Use of Cryptographic Algorithms (1)

- Requirements on an IPSec implementation are classified into different classes
 - "MUST", "MUST NOT", "REQUIRED", "SHOULD", "SHOULD NOT" and "MAY"
 - "SHOULD+", "SHOULD-", "MUST-"
- Requirements on an IPSec implementation of the ESP protocol:

Requirement	Encryption Algorithm	Reference	Notes
MUST	NULL		(1)
MUST-	3DES-CBC	[RFC2451]	
SHOULD+	AES-CBC with 128-bit keys	[RFC3602]	
SHOULD	AES-CTR	[RFC3686]	
SHOULD NOT	DES-CBC	[RFC2405]	(2)

Requirement	Authentication Algorithm	Reference	Notes
MUST	NULL		(1)
MUST	HMAC-SHA1-96	[RFC2404]	(3)
SHOULD+	AES-XCBC-MAC-96	[RFC3566]	(3)
MAY	HMAC-MD5-96	[RFC2403]	(3, 4)

IPSec's Use of Cryptographic Algorithms (2)

- Notes
 - 1) Since ESP encryption and authentication are optional, support for the two "NULL" algorithms is required to maintain consistency with the way these services are negotiated. While authentication and encryption can each be "NULL", they MUST NOT be both "NULL".
 - 2) DES, with its small key size and publicly demonstrated and open-design special-purpose cracking hardware, is of questionable security for general use.
 - 3) The "-96" in the algorithms mentioned above means that the output of the hash function is truncated to the 96 leftmost bits
 - 4) Weaknesses have become apparent in MD5; however these should not affect the use of MD5 with HMAC
- Algorithms for AH are the same as the authentication algorithms for ESP except that "NULL" is not allowed

Overview

- Introduction
 - Brief introduction to the Internet Protocol (IP) suite
 - Security problems of IP and objectives of IPSec
- The IPSec architecture:
 - Overview
 - IP Replay Protection
 - IPSec security protocol modes:
 - Transport mode
 - Tunnel mode
 - IP Security Policies and the Security Policy Database (SPD)
 - Security associations (SA) and the SA Database (SAD)
 - Implementation alternatives
- IPSec security protocols:
 - Encapsulating Security Payload (ESP)
 - Authentication Header (AH)
- Entity Authentication and Key Establishment with the Internet Key Exchange (IKE)

Overview

- Entity Authentication and Key Establishment with the Internet Key Exchange Version 2 (IKE2)
 - Introduction
 - Protocol Exchanges
 - Generation of Keying Material
 - Negotiation of Security Associations
 - Advanced IKEv2 Features
 - Message and Payload Format

IKEv2 – Introduction (1) - Refresher

- Prior to any packet being protected by IPSec, a *Security Association* (SA) has to be established between the two "cryptographic endpoints" providing the protection
- SA establishment can be realized:
 - *Manually*
 - ➔ regarding key management, this approach does not scale well in large networks, and keys have to be distributed confidentially
 - ➔ Manual establishment can be used only in very restricted configurations (e.g. between two VPN gateways) and should not be a permanent solution
 - *Dynamically*, using a standardized authentication & key management protocol
- A standardized method for SA establishment is the *Internet Key Exchange* protocol (IKE)

IKEv2 – Introduction (2)

- IKE was standardized by the IETF in [RFC2409] (Nov. 1998)
- IKEv2 was standardized in [RFC4306] (Dec. 2005)
 - Parts of IKE (version 1) were poorly specified and the specification was spread over multiple, overlapping documents (RFCs 2407, 2408, 2409)
 - IKEv1 provided multiple key establishment modes with different security properties to choose from.
 - Some of these modes are believed to be insecure.
 - Some other modes have not been used and were just adding complexity in the specification
 - Critique on IKEv1 (and IPSec in general) can be found in [Fer98a]
 - IKEv2 provides a unified authentication and key establishment protocol, which tries to achieve a reasonable tradeoff between features to choose from, overall protocol complexity and reasonable security under a realistic threat model
- ➔ In the following, we will restrict our discussion to IKEv2

IKEv2 – Introduction (3)

- Interoperability with IKE (version 1)
 - IKEv2 does *NOT* interoperate with version 1
 - But it has enough of the header format in common that both versions can unambiguously run over the same UDP port (ports 500 and 4500 are the corresponding “well-known” ports)
- IKEv2 provides
 - *Mutual authentication* of the “Initiator” and the “Responder”
 - Negotiation of *cryptographic suites* (a complete set of algorithms used for security associations)
 - Support for *DoS mitigation* by the use of *cookies*
 - Integrated support for requesting an IP address (remote address acquisition), which is useful for VPNs
- IKEv2’s latency in the common case is 2 round trips (i.e. 4 messages)

Basic Protocol Design – Protocol Exchanges (1)

- All IKEv2 communications consist of pairs of messages:
 - a request and a response.
- Every request requires a response
- The pair (request, response) is called an *exchange*
- An IKEv2 protocol run starts with two exchanges:
 - *IKE_SA_INIT*
 - negotiates security parameters for an IKE security association (*IKE_SA*), sends nonces (Nonce: Number used ONCE) and Diffie-Hellman values
 - *IKE_SA* is a set of security associations used to encrypt and integrity-protect all the remaining IKE exchanges
 - *IKE_AUTH*
 - authenticates the previous messages, transmits identities, proves knowledge of the secrets corresponding to the identities and creates a first *CHILD_SA*
 - A *CHILD_SA* is a set of security associations used to encrypt and/or integrity-protect data with AH/ESP
 - “*CHILD_SA*” is synonymous to the common definition of an SA for IPSec AH and ESP in RFC’s 4301, 4302 & 4303

Basic Protocol Design – Protocol Exchanges (2)

- *IKE_SA_INIT* and *IKE_AUTH* have to be completed in this strict order before any other exchanges
- Additional IKEv2 exchanges might be
 - *CREATE_CHILD_SA*
 - Used to create another *CHILD_SA*
 - Can also be used for *re-keying*
 - *INFORMATIONAL*
 - Is used for “keep-alive”, deleting an SA, reporting error conditions and other housekeeping
- Some remarks
 - The *IKE_AUTH* includes the negotiation of an *CHILD_SA* simply in order to reduce the latency of IKEv2. The negotiation is *CHILD_SA* is “piggybacked” by the *IKE_AUTH* exchange
 - IKEv2 uses UDP as a transport protocol, which does not provide reliable transport. For all exchanges, it is in the responsibility of the requester to ensure reliability, i.e., to retransmit a request after a timeout has occurred

IKEv2 Message Payloads

- A IKEv2 message consists of a message header *HDR* and one or more other fields called „payloads“
- Payload types
 - AUTH: Authentication
 - CERT: Certificate
 - CERTREQ: Certificate Request
 - CP: Configuration
 - E: Encrypted
 - ID_i / ID_r: Identification
 - KE: Key Exchange
 - N_i, N_r: Nonce
 - SA: Security Association
 - TS_i / TS_r: Traffic Selector
 - N: Notify (The Notify payload is used for different purposes)
- Other payloads will not be addressed in this Chapter and can be found in [RFC4306]

IKEv2 Message Header

- HDR contains
 - the Security Parameter Indexes (SPIs) for the *IKE_SA*,
 - the IKE version number (in this case IKEv2 obviously “2”),
 - and flags of various sorts
- Notation
 - “HDR(A,B)” indicates the IKEv2 message header where the initiator’s and responder’s SPI are respectively *A* and *B*
- Note that unlike ESP and AH where only the recipient’s SPI appears in the header of a message, in IKEv2 the sender’s SPI is also sent in every message.
- In the first message of an initial IKEv2 exchange, the initiator will not know the responder’s SPI value and will therefore set that field to zero
- Notation in the following protocol exchanges
 - the protocol participants are called *Initiator (I)* and *Responder (R)*
 - “[...]” marks optional components

IKEv2 – IKE_SA_INIT Exchange (1)

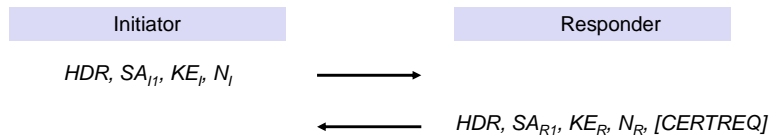

- SA_{I1}: the cryptographic suites which the Initiator supports
- SA_{R1}: the Responder chooses a cryptographic suite from SA_{I1}
- KE_I, KE_R: Initiator and Responder’s public Diffie-Hellman values, respectively
- N_I, N_R: Initiator and Responder’s (random) nonces, respectively
- CERTREQ: (optional) certificate request payload which is used for authentication via certificates

Generating Keying Material Using Pseudo-Random Functions

- In the context of a *IKE_SA*, 4 cryptographic algorithms are negotiated
 - Encryption algorithm
 - Integrity protection algorithm
 - Diffie-Hellman group (i.e. DH parameters *p* and *g*)
 - pseudo-random function (prf),
- Notation
 - In the remaining of this chapter, prf is a pseudo-random function with two input parameters
 - E.g. $\text{prf}(K,S) = \text{HMAC}(K,S) = \text{H}(K \text{ XOR opad} \mid \text{H}(K \text{ XOR ipad} \mid S))$ where *H* is a cryptographic hash function, such as MD5 or SHA-1
- The “prf” negotiated during the *IKE_SA_INIT* exchange is used for the construction of all subsequent keying material for *IKE_SA* and *CHILD_SAs*
- Since the amount of keying material needed may be greater than the size of the output of the prf algorithm, prf is used iteratively
 - $\text{prf}^+(K,S) = T1 \mid T2 \mid T3 \mid T4 \mid \dots$
 - $T1 = \text{prf}(K, S \mid 0x01)$
 - $T2 = \text{prf}(K, T1 \mid S \mid 0x02)$
 - $T3 = \text{prf}(K, T2 \mid S \mid 0x03)$
 - $T4 = \text{prf}(K, T3 \mid S \mid 0x04)$

Generating Keying Material after IKE_SA_INIT

- The DH handshake in the IKE_SA_INIT exchange enables both parties to generate a shared secret key called *SKEYSEED*,
 - $SKEYSEED = \text{prf}(N_i | N_r, g^{ir})$
- Furthermore, each peer generates keying material consisting of 7 different keys $\{SK_d | SK_{ai} | SK_{ar} | SK_{ei} | SK_{er} | SK_{pi} | SK_{pr}\}$

$$= \text{prf+}(SKEYSEED, N_i | N_r | SPI_i | SPI_r)$$
- 4 keys are used for integrity protection and encryption for all the remaining IKE messages in each direction
 - SK_{ai} and SK_{ar} are used as keys for integrity-protecting subsequent IKEv2 exchanges
 - SK_{ei} and SK_{er} are used for encrypting (and decrypting) messages in subsequent IKEv2 exchanges
- SK_d used for deriving new keys for the CHILD_SAs established with this IKE_SA
- SK_{pi} and SK_{pr} will be used when generating the AUTH payloads in the *IKE_AUTH* exchange

IKEv2 – IKE_SA_INIT Exchange (2)

- After the first exchange,
 - the DH handshake is complete,
 - keying material for the IKE_SA is generated
 - however, the shared secret *SKEYSEED* (and consequently all keys derived from *SKEYSEED*) is still *unauthenticated*
- Both parties still have to verify the identity of the other side in the upcoming *IKE_AUTH* exchange
- All but the headers of all the IKEv2 messages that follow are encrypted and integrity protected

IKEv2 – IKE_AUTH Exchange

- In the following, $SK\{...\}$ indicates that these payloads are encrypted and integrity protected using that direction's SK_e and SK_a :

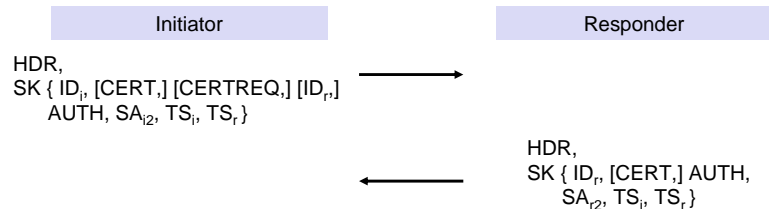

- The Initiator (Responder) asserts his identity in the ID_1 (ID_R) payload
- The Initiator (Responder) proves knowledge of the secret corresponding to ID_1 (ID_R) and integrity protects the contents of the first (second) message in the *IKE_SA_INIT* exchange, using the AUTH payload
- The initiator may include a certificate or a certificate chain and a certificate request, if authentication should be using digital signatures
- The remaining payloads (SA_{i2} , SA_{r2} , TS_i and TS_r) are used for establishment of the first CHILD_SA

IKEv2 – Authentication (1)

- IKEv2 supports the authentication of peers using either public key signatures or a long-term pre-shared secret
- “Initiator” and “Responder” are authenticated by having each sign (or MAC using a shared secret as the key) a block of data
- The resulting value (digital signature or MAC) will be respectively the AUTH payload in the *IKE_AUTH* exchange
 - ➔ the Initiator/Responder can authenticate the other peer by verifying the validity of the received AUTH payload
- The initiator signs the concatenated string of:
 - The whole payload of his *IKE_SA_INIT* message
 - Responder's nonce N_r
 - $\text{prf}(SK_{pi}, ID_i')$ (the prf algorithm negotiated in the *IKE_SA_INIT* exchange is used)
- The responder signs the concatenated string of:
 - The whole payload of his *IKE_SA_INIT* message
 - Initiator's nonce N_i
 - $\text{prf}(SK_{pr}, ID_r')$
- ID_i' , ID_r' are the entire ID payloads excluding the fixed headers

Dependencies between Different IKEv2 Payloads and Generated Keys

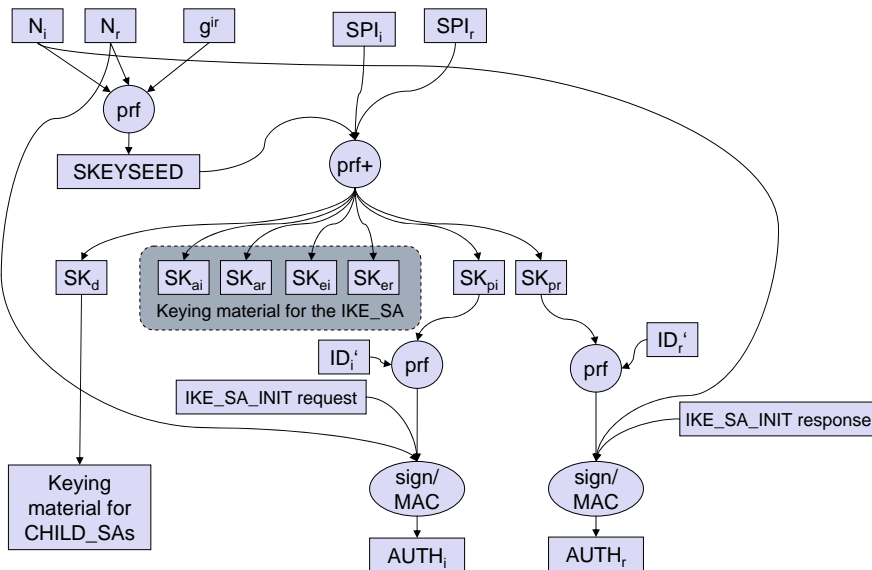

IKEv2 – Authentication (2)

- The Initiator (Responder) assert his/her identity by including the ID_i' (ID_r') in the generation of the AUTH payload
- It is important that each peer includes the other side's (freshly generated) nonce (N_i and N_r) in the generation of the AUTH payload in order to guarantee to the other peer that he/she is alive and that it is not a replayed protocol run
- The entire IKE_SA_INIT request (response) is included in the generation of the AUTH payload. This guarantees the integrity of the IKE_SA_INIT exchange
- In particular, this guarantees that the proposed algorithms in the SA negotiation (SA_{I1} , SA_{R1}) and the DH value (KE_i and KE_r) have not been modified by an attacker
- SK_{pi} and SK_{pr} are derived from the SKEYSEED and are involved in the generation of the AUTH payload respectively. Therefore, each peer can verify that the freshly generated SKEYSEED is correct

IKEv2 – Authentication (3)

- In some cases, it is possible that the Initiator uses a MAC to generate the AUTH payload while the Responder generates a digital signature to generate the AUTH payload
- This could be the case, e.g., if the initiator is a user's host connecting to an IPSec-based VPN server, where
 - the user's host is authenticated based on the user's password (or a key generated from the user's password)
 - the VPN gateway is authenticated using its certificate
- In case authentication is based on a certificate, IKEv2 does not enforce or suggest any algorithm for the digital signature. The certificate determines the algorithm used for the signature, e.g. RSA, DSA (El-Gamal), or ECC

IKEv2 – CREATE_CHILD_SA exchange (1)

- This exchange may be initiated by either end of the IKE_SA after the initial exchanges are completed

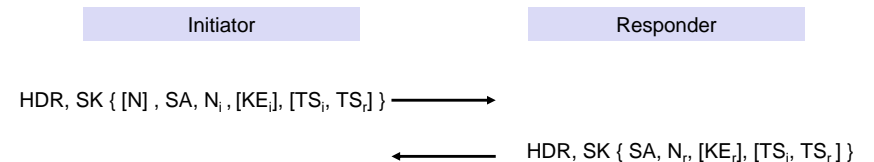

- N: a notify payload; is only used in case in case of re-keying
- SA: SA offer(s)
- N_i , N_r : nonces
- KE_i , KE_r : optional DH values
- TS_i , TS_r : proposed traffic selector payloads

IKEv2 – CREATE_CHILD_SA exchange (2)

- ❑ A single (CREATE_)CHILD_SA negotiation may result in multiple security associations (maximum 4)
- ❑ Requesting an internal address (and other configuration information, i.e., addresses of DNS servers) on a remote network can be done by including a $CP_{request}$ field in the request
- ❑ The IPsec Remote Access Server (e.g. a IPsec-based VPN gateway) may manages these addresses, e.g., via DHCP

Generating Keying Material for a CHILD_SA

- ❑ Exercise
 - Read the Section 2.17 “Generating Keying Material for CHILD_SAs” of [RFC4306] and write down how the necessary keying material for a CHILD_SA is generated

IKEv2 - Protection against flooding attacks

- ❑ Flooding the responder with IKE_SA_INIT requests from forged IP addresses may result in state and CPU exhaustion attacks
 - ❑ The responder may switch to an alternative protocol (which involves 3 exchanges) in case there's a large number of “half-open” IKE_SAs
 - ❑ In the alternative protocol run, a *Cookie* is exchanged before any state is preserved and any CPU-intensive operations are done at the responder:
 1. $I \rightarrow R: HDR(A,0), SA_{I1}, KE_I, N_I$
 2. $R \rightarrow I: HDR(A,0), N(Cookie);$
where “N(Cookie)” is Notify payload with the Cookie
 3. $I \rightarrow R: HDR(A,0), N(Cookie), SA_{I1}, KE_I, N_I$
 4. $R \rightarrow I: HDR(A,B), SA_{R1}, KE_R, N_R, [CERTREQ]$
 5. $I \rightarrow R: HDR(A,B), \{ ID_I, [CERT_I], [CERTREQ_I], [ID_R], AUTH, SA_{I2}, TS_I, TS_R \}_{SK_I}$
 6. $R \rightarrow I: HDR(A, B), \{ ID_R, [CERT_I], AUTH, SA_{R2}, TS_I, TS_R \}_{SK_R}$
- This DoS mitigation measure solely assures that the initiator is able to receive and send packets from its IP address from the IP packet header
- The Cookie should be generated in a way to not require any state:
i.e., $Cookie = \langle Version | IDofSecret \rangle | Hash(N_I | IP_I | SPI_I | \langle secret \rangle)$

Rekeying

- ❑ Secret keys should only be used for a limited amount of time and to protect a limited amount of data
 - ❑ 2 possible solutions in IKEv2:
 1. Establish new security associations
 2. Re-establishment of security associations by *rekeying* (optional feature which makes use of the CREATE_CHILD_SA exchange)
- ➔ Each endpoint is responsible for enforcing its own lifetime policy on SAs

Traffic Selector Negotiation

- Traffic selector (TS) payloads allow endpoints to communicate some of their Security Policy Database (SPD) information to their peers
 - New feature in IKEv2
 - May be dynamically updated
 - May serve as a consistency check in some scenarios to assure that the SPDs are consistent
- Each TS contains the following information
 - Address range (IPv4 or IPv6)
 - Port range
 - IP protocol ID

IKEv2 - INFORMATIONAL Exchange

- INFORMATIONAL exchanges are used for
 - Control messages (delete SA, configuration, ...)
 - Error messages
 - Notifications of certain events
 - Keep-alive messages (empty payload)
- INFORMATIONAL exchanges must only occur after the initial exchanges and are protected with the IKE_SA

IKEv2 – Basic Message Format (1)

- As mentioned above, an IKEv2 message consist of an IKEv2 header and one or more IKEv2 payloads

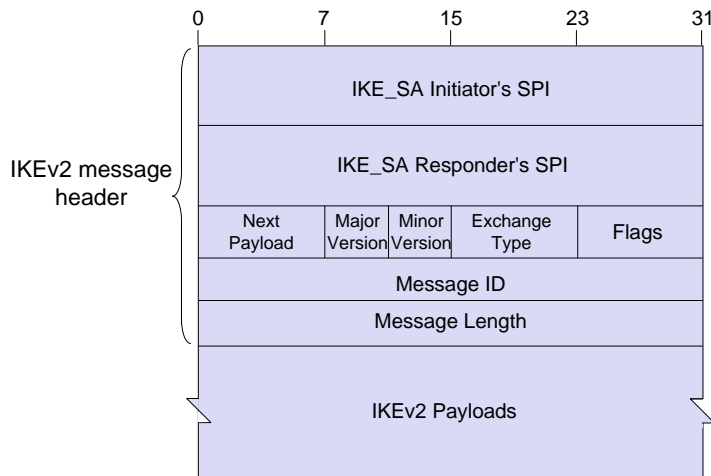

IKEv2 – Basic Message Format (2)

- *IKE_SA Initiator's SPI:* (8 bytes)
 - Identifies the IKE security association at the initiator side.
 - Can not be zero
- *IKE_SA Responder's SPI:* (8 bytes)
 - Identifies the IKE security association at the responder side.
 - Must be zero in the first message of the IKE_SA_INIT exchange (since at this time the Initiator does not know the SPI value at the Responder's side)
- *Next payload:* (1 byte)
 - Indicates the type of payload that immediately follows the header
- *Major & minor version:* (4 bits)
 - identify the supported versions of the IKE protocol.
- *Exchange type:*
 - Indicates the type of exchange being used (IKE_SA_INIT, IKE_AUTH, etc.)
- *Flags*

IKEv2 – Basic Message Format (3)

- **Message ID:** (4 bytes)
 - Used to identify messages to control retransmission of lost packets
 - Also used to match responses to the corresponding requests: each response message must carry the same message ID as the corresponding request
- **Message Length:** (4 bytes)
 - Total length of the message (header + payload) in bytes
- **Payload:**
 - All IKEv2 payloads start with a common payload header

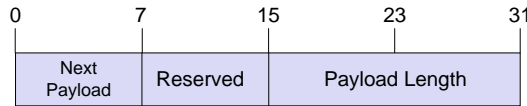

- **Next Payload:** the payload type of the next payload in the message
- **Payload Length:** total length of current payload (including this header)

Payload Types (1)

- Payload Type Values (from [RFC4306] Section 3.2)

Next Payload Type	Notation	Value
No Next Payload		0
RESERVED		1-32
Security Association	SA	33
Key Exchange	KE	34
Identification – Initiator	IDi	35
Identification – Responder	IDr	36
Certificate	CERT	37
Certificate Request	CERTREQ	38
Authentication	AUTH	39
Nonce	Ni, Nr	40

Payload Types (2)

- Payload Type Values (continued)

Next Payload Type	Notation	Value
Notify	N	41
Delete	D	42
Vendor ID	V	43
Traffic Selector – Initiator	TSi	44
Traffic Selector – Responder	TSr	45
Encrypted	E	46
Configuration	CP	47
Extensible Authentication	EAP	48
RESERVED TO IANA		49-127
PRIVATE USE		128-255

IKEv2 - SA Negotiation (1)

- An SA payload may contain multiple “proposals”
- Each “proposal” contains a set of security protocols (IKEv2, AH, ESP) with the corresponding cryptographic algorithms to be used
- Allowed transform types for:
 - AH: integrity check algorithms
 - ESP: encryption algorithm and integrity check algorithm
 - IKEv2: Diffie-Hellman group, prf algorithm, encryption algorithm and integrity check algorithm

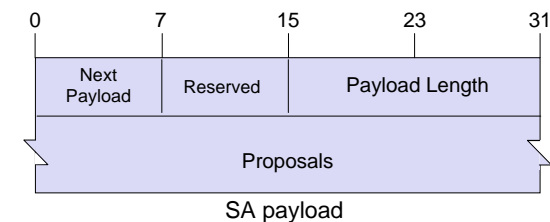

IKEv2 - SA Negotiation (2)

- Proposals are ordered from most preferred to least preferred
- Each proposal is identified with a proposal number: „Proposal #“
 - Each proposal substructure (see next slide) has the same Proposal # as the previous one or be one (1) greater
 - The first Proposal MUST have a “Proposal #” of one (1)
 - If two successive proposal substructures have the same “Proposal #”, it means that the proposal consists of the first structure AND the second
 - e.g. a proposal of AH AND ESP would have two proposal substructures, one for AH and one for ESP (but with a different “protocol ID”)
- Each proposal substructure contains one or more “transforms”
- Each transform specifies a cryptographic algorithm and may contain additional “attributes” that are required for this cryptographic algorithm
- Therefore, security associations are encoded in a hierarchical manner:
 - SA payload → proposals → protocols → transforms → attributes

IKEv2 – The Proposal Substructure

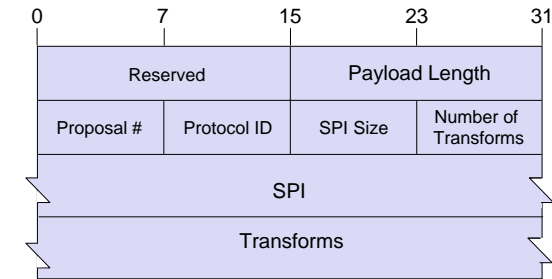

- *Proposal #* (see last slide)
- *Protocol ID* specifies the protocol identifier, i.e. AH or ESP, IKE(v2)
- *SPI Size* specifies the length of the contained SPI value
- *Number of Transforms* specifies how many transforms belong to this proposal
 - e.g. if “protocol ID” is „ESP”, the proposal may contain several transforms for data integrity and encryption, e.g. ENCR_3DES, ENCR_AES_CTR, AUTH_HMAC_SHA1_96 and AUTH_AES_XCBC_96
 - Note however, that in the response, the Responder must choose a unique algorithm for a each purpose, e.g. ENCR_3DES and AUTH_HMAC_SHA1_96

IKEv2 – The Transform Substructure

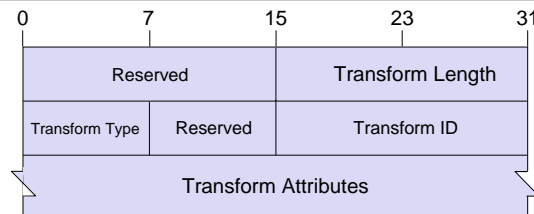

- A transform determines a cryptographic algorithm to be used to secure the communications channel
- Transform types:
 - Integrity check algorithms (INTEG)
 - Encryption algorithm (ENCR)
 - Diffie-Hellman group (D-H),
 - prf algorithm (PRF)
- Each transform is uniquely identified by a *Transform ID*,
 - e.g. ENCR_AES_CTR, ENCR_AES_CBC, PRF_HMAC_MD5, etc.
 - Identifiers of the different transforms are listed in [RFC4306] Section 3.3.2
- Attributes: only one attribute is defined in [RFC4306]
 - Key length: in case an algorithm with variable key length is used, e.g. AES

IKEv2 - SA Negotiation (3)

- Responders must select a single proposal from the ones proposed in the initiator's request (or reject all offers if none are acceptable)
- Each of the proposal substructures in the response must contain a single transform of each transform type
- The responder should retain the *Proposal #* field in the proposal payload
 - Retention of proposal numbers should speed the initiator's protocol processing by avoiding the need to compare the responder's selection with every offered option
 - This value enable the initiator to perform the comparison directly and quickly
- The initiator must verify that the SA payload received from the responder matches one of the proposals sent initially

SA Negotiation – Example (1)

- ❑ This example shows an ESP and AH protection suite:
- ❑ Two transforms are suggested for ESP
 - ENCR: ENCR_3DES
 - ENCR: ENCR_AES_CTR (with 256 bit key length)
- ❑ The responder must select from the two transforms proposed for ESP
- ❑ a single transform is suggested for AH
 - INTEG: AUTH_HMAC_SHA1_96
- ❑ The resulting protection suite will be:
 - either ENCR_3DES and AUTH_HMAC_SHA1_96,
 - or ENCR_AES_CTR (with 256 bit key length) and AUTH_HMAC_SHA1_96,depending on which ESP transform was selected by the responder

SA Negotiation – Example (2)

- ❑ In this case, the SA payload in the initiator's request will look as follow:
 - Proposal 1: ESP:
 - ENCR: ENCR_3DES, ENCR : ENCR_AES_CTR (with 256 bit key length)
 - Proposal 1: AH
 - INTEG: AUTH_HMAC_SHA1_96
- ❑ The SA payload in the responder's response will look as follow:
 - Either
 - Proposal 1: ESP:
 - Transform 1: ENCR_3DES
 - Proposal 1: AH
 - Transform 1: AUTH_HMAC_SHA1_96
 - Or
 - Proposal 1: ESP:
 - Transform 2 : ENCR_AES_CTR (with 256 bit key length)
 - Proposal 1: AH
 - Transform 1: AUTH_HMAC_SHA1_96
- ❑ Remainder:
 - Two or more proposal substructures with the same proposal # (as shown in the example above) refer to the same proposal
 - The SA negotiation in this example will result in 4 SAs: 2 SAs per direction

Brief Comparison between IKE and IKEv2 (1)

- ❑ IKEv2 reduced complexity by omitting some features and some complexity that have been useless
- ❑ IKE supports 8 modes for authentication
 - Shared secret, digital signatures, 2 versions of authentication based on public key encryption
 - Each of the 4 modes above can be performed in two different modes: the "main mode" (with 6 messages), and the "aggressive mode" with 3 messages
- ❑ IKEv2 supports different authentication methods using only one mode!
 - Using a different authentication method affects only the way how the AUTH payload is computed and not the whole message exchange
- ❑ IKE (version 1) is currently more widespread
- ❑ However, IKEv2 is upcoming
- ❑ Several open source implementations of IKEv2 already exist
 - *racoon2*
 - *Ikev2*
 - *OpenIKEv2*
 - *strongSwan*

Brief Comparison between IKE and IKEv2 (2)

- ❑ IKE (v1) consists of 2 phases
- ❑ *Phase I:*
 - Corresponds to the *IKE_SA_INIT* and *IKE_AUTH* exchanges in IKEv2
 - Can be performed in two different modes
 - Main mode: with 6 messages
 - Aggressive mode: with only 3 messages. However, it is considered to be insecure
 - ➔ compared to the IKEv1 main mode, IKEv2 reduces the number of exchanged messages from 6 to 4 messages
- ❑ *Phase II:*
 - Used to create IPsec SA and is performed in the so-called quick mode with 3 messages
 - ➔ Since the negotiation of a CHILD_SA in IKEv2 is piggybacked in the *IKE_AUTH* exchange, this phase becomes useless in IKEv2
 - ➔ IKEv2 saves even more messages and round trips

Summary (1)

- ❑ IPsec is IETF's security architecture for the Internet Protocol
- ❑ It provides the following security services to IP packets:
 - Data origin authentication
 - Replay protection
 - Confidentiality
- ❑ It can be realized in end systems or intermediate systems (gateways)
- ❑ Two fundamental security protocols have been defined:
 - Authentication header (AH)
 - Encapsulating security payload (ESP)
- ❑ Both protocols can be run in „transport mode“ or „tunnel mode“
- ❑ Authentication, SA negotiation and key management can be realized with the Internet Key Exchange Protocol IKEv2
- ❑ Authentication can be performed based on certificates or a long-term pre-shared key
- ❑ IKEv2 provides DoS protection using cookies

Summary (2)

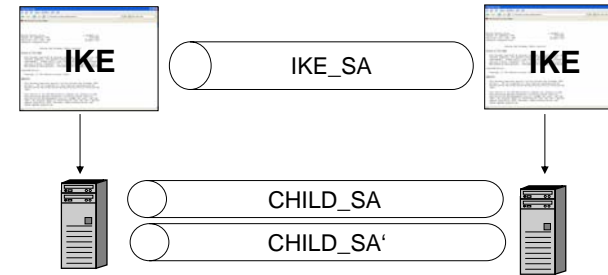

- ❑ *IKE_SA* is a set of security associations established after the initial IKEv2 exchange (*IKE_SA_INIT*) and used to encrypt and integrity-protect all the remaining IKE exchanges
- ❑ *CHILD_SA* is a set of security associations used to protect IP traffic with the AH/ESP protocol
- ❑ AH provides data integrity, replay protection
- ❑ ESP provides data integrity, replay protection and encryption

Additional References (1)

- [Fer98a] N. Ferguson, B. Schneier. *A Cryptographic Evaluation of Ipsec*. <http://www.schneier.com/paper-ipsec.html>, 1998.
- [RFC2403] C. Madson, R. Glenn. *The Use of HMAC-MD5-96 within ESP and AH*. RFC 2403, IETF, 1998.
- [RFC2404] C. Madson, R. Glenn. *The Use of HMAC-SHA-1-96 within ESP and AH*. RFC 2404, IETF, 1998.
- [RFC2405] C. Madson, N. Doraswami. "The ESP DES-CBC Cipher Algorithm With Explicit IV" RFC 2405, IETF, 1998.
- [RFC2407] D. Piper. *The Internet IP Security Domain of Interpretation for ISAKMP*. RFC 2407, IETF, 1998.
- [RFC2408] D. Maughan, M. Schertler, M. Schneider, J. Turner. *Internet Security Association and Key Management Protocol (ISAKMP)*. RFC 2408, IETF, 1998.
- [RFC2409] D. Harkins, D. Carrel. *The Internet Key Exchange (IKE)*. RFC 2409, IETF, 1998.
- [RFC2451] R. Pereira, "The ESP CBC-Mode Cipher Algorithms", RFC 2451, IETF, November 1998
- [RFC3566] S. Frankel, „The AES-XCBC-MAC-96 Algorithm and Its Use With IPsec“, RFC 3566, IETF, 2003
- [RFC3602] S. Frankel, "The AES-CBC Cipher Algorithm and Its Use with IPsec", RFC 3602 IETF, September 2003
- [RFC3686] R. Housley, "Using Advanced Encryption Standard (AES) Counter Mode With IPsec Encapsulating Security Payload (ESP)", RFC 3686 IETF, January 2004

Additional References (2)

- [RFC4301] R. Atkinson, S. Kent. *Security Architecture for the Internet Protocol*. RFC 2401, Internet Engineering Taskforce (IETF), 2005
- [RFC4302] R. Atkinson, S. Kent. *IP Authentication Header (AH)*. RFC 4302, IETF, 2005
- [RFC4303] R. Atkinson, S. Kent. *IP Encapsulating Security Payload (ESP)*. RFC 4303, IETF, December 2005
- [RFC4305] D. Eastlake, „Cryptographic Algorithm Implementation Requirements for Encapsulating Security Payload (ESP) and Authentication Header (AH)“, RFC 4305, IETF, 2005
- [RFC 4306] C. Kaufman. *Internet Key Exchange (IKEv2) Protocol*. RFC 4306, IETF, 2005.